

FMG50AQ120N6

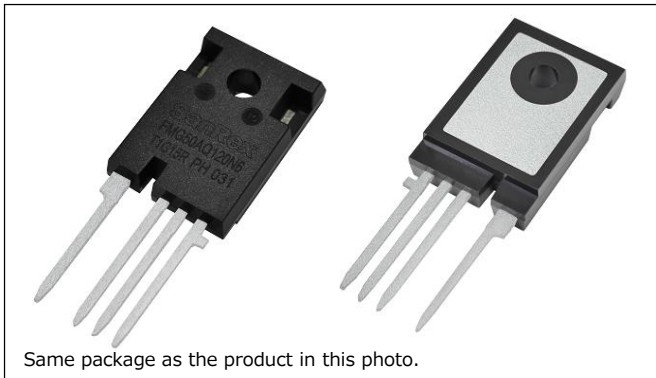

$V_{RRM} = 1200V$
 $I_{T(AV)} = 50A$

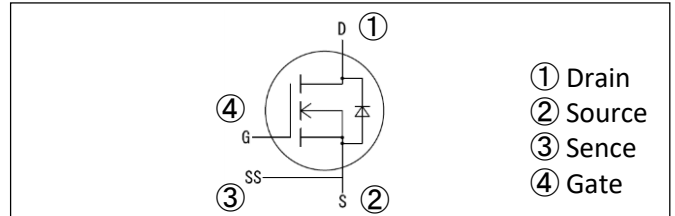

■ TO-247-4L package SiC MOSFET

Advantages

- Low power loss thanks to low $R_{DS(on)}$ and low switching loss.
- Low temperature dependency of $R_{DS(on)}$ reducing thermal runaway risks at high temperature operation
- Safe gate driving at high frequency operation through optimized $V_{GS(th)}$ (4.0V)
- The four-pin TO-247-4L package further enhancing the high-speed switching performance of SiC MOSFET
- Top level short circuit tolerance enabling safety design of equipment
- No additional FWD required

Applications

- Industrial Inverters, DC-DC Converters, EV Battery Chargers, Resonant Power Supply

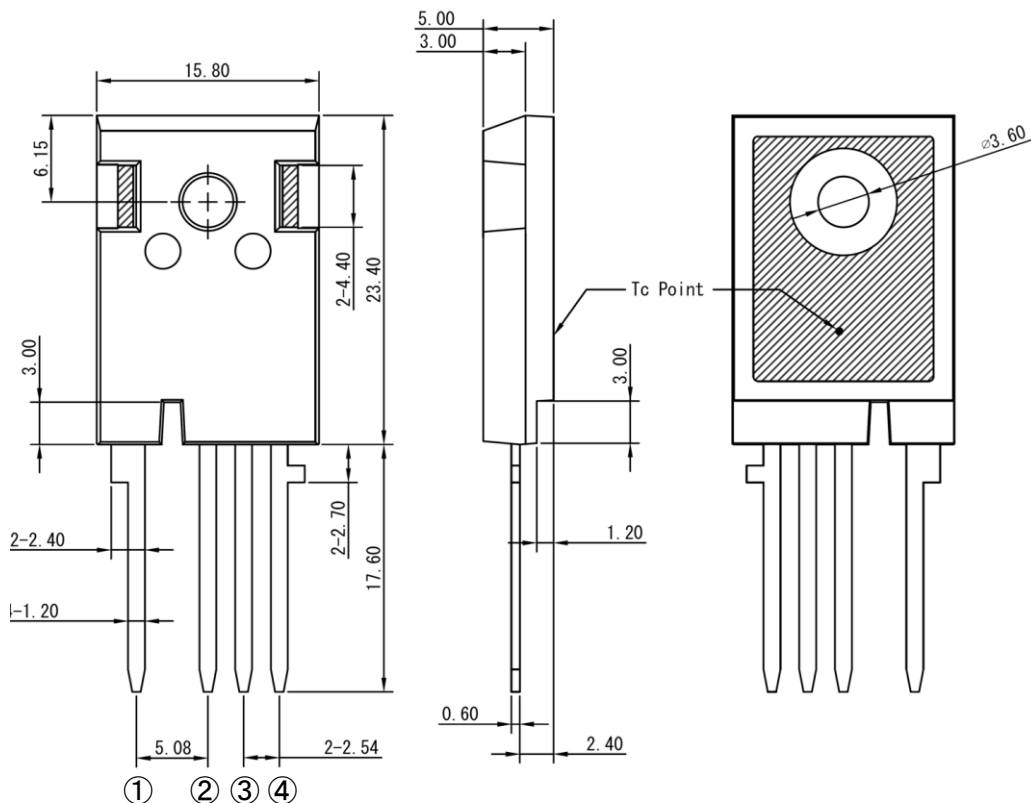

FMG50AQ120N6

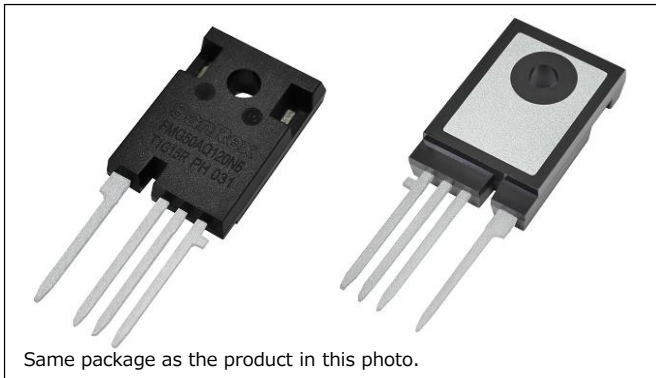

$V_{RRM} = 1200V$
 $I_T(AV) = 50A$

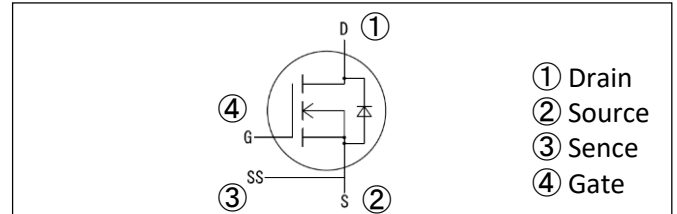

■ TO-247-4L package SiC MOSFET

特長

- 小さいオン抵抗とスイッチングロスによる低損失
- 熱暴走に強い温度変化の小さいオン抵抗
- 高周波動作での高いノイズ特性をもたらすゲート特性 ($V_{GS(th)} : 4.0V$)
- SiC MOSFETの高速スイッチング性能を引き出す4ピンのTO-247-4Lパッケージを採用
- 回路保護設計が容易なトップレベルの短絡耐量
- 外付けFWD不要

用途

- 産業用インバータ、DC-DCコンバータ、EV充電器、共振電源

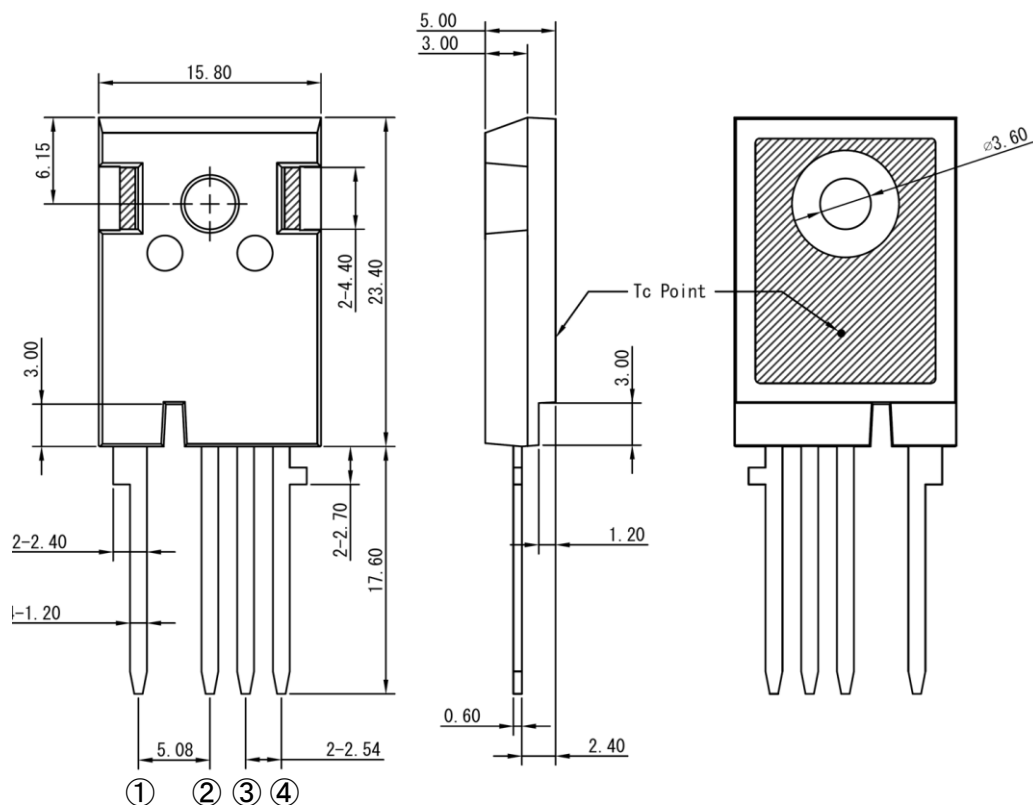

■ Maximum Ratings (T_j=25°C unless otherwise specified)

Item	Symbol	Unit	Ratings	Conditions
Drain-Source Voltage	V _{DSS}	V	1200	
Gate-Source Voltage(+)	V _{GSS}	V	22	
Gate-Source Voltage(-)		V	-7	
Drain Current	I _D	A	50	V _{GS} =20V, T _c =108°C, DC
	I _{D(pulse)}	A	150	Pulse
Source Current	I _S	A	50	V _{GS} =-5V, T _c =108°C, DC
	I _{S(pulse)}	A	150	Pulse
Total Power Dissipation	P _{tot}	W	440	T _c =25°C
Operating Junction Temperature	T _j	°C	-40~+150	
Storage Temperature	T _{stg}	°C	-40~+150	
Isolation Voltage	V _{iso}	V	2500	AC, RMS, 1min

■ Electrical Characteristics (T_j=25°C unless otherwise specified)

Item	Symbol	Unit	Ratings			Conditions
			Min.	Typ.	Max.	
Drain-Source Breakdown Voltage	V _{(BR)DSS}	V	1200			V _{GS} =0V, I _D =100μA
Static Drain-Source On-State Voltage	V _{DS(on)}	V		0.65	1.40	V _{GS} =20V, I _D =50A
				0.75	1.50	V _{GS} =20V, I _D =50A, T _j =150°C
On-State Resistance	R _{DS(on)}	mΩ		13.0	28.0	V _{GS} =20V, I _D =50A
				15.0	30.0	V _{GS} =20V, I _D =50A, T _j =150°C
Drain Cutoff Current	I _{DSS}	μA			100	V _{DS} =1200V, V _{GS} =0V
Gate-Source Threshold Voltage	V _{GS(th)}	V	3	4	5	V _{DS} =10V, I _D =1.5mA
Gate-Source Leakage Current	I _{GSS}	nA			100	V _{GS} =20V, V _{DS} =0V
Switching Characteristics	t _{d(on)}	ns		54		I _D =50A, V _{DS} =600V, V _{GS} =+20V/-5V, R _G =6.8Ω, L=480μH
	t _r	ns		48		
	t _{rr}	ns		42		
	t _{d(off)}	ns		92		
	t _f	ns		62		
Total Gate Charge	Q _G	nC		290		I _D =50A, V _{DS} =600V, V _{GS} =+20V/-5V
Input Capacitance	C _{iss}	nF		9.0		V _{DS} =20V, V _{GS} =0V, f=100kHz
Output Capacitance	C _{oss}	nF		2.5		
Reverse Transfer Capacitance	C _{rss}	nF		0.2		
Source-Drain Voltage	V _{SD}	V		2.65	2.90	V _{GS} =-5V, I _S =50A
				2.65	2.95	V _{GS} =-5V, I _S =50A, T _j =150°C
Total Capacitive Charge	Q _c	nC		700		I _{SD} =50A, V _{DS} =600V, di _{SD} /dt=800A/μs, V _{GS} =-5V
Internal Gate Resistance	R _{G(int)}	Ω		0.8		
Internal Stray Inductance	L _s	nH		6		between Drain and Source (root of terminal)

■ Thermal Characteristics (T_j=25°C unless otherwise specified)

Junction-to-Case Thermal Resistance	R _{th(j-c)}	°C/W		0.22	0.28	
Case-to-Heat sink Thermal Resistance	R _{th(c-f)}	°C/W		1.7		Thermal conductivity = 9×10 ⁻³ W/cm·°C

■ Mechanical Characteristics (T_j=25°C unless otherwise specified)

Weight	-	g		4.8		
Mounting Torque(M3)	-	N·m			0.8	Main terminals and mounting to heat sink Recommended value 0.4-0.5N·m

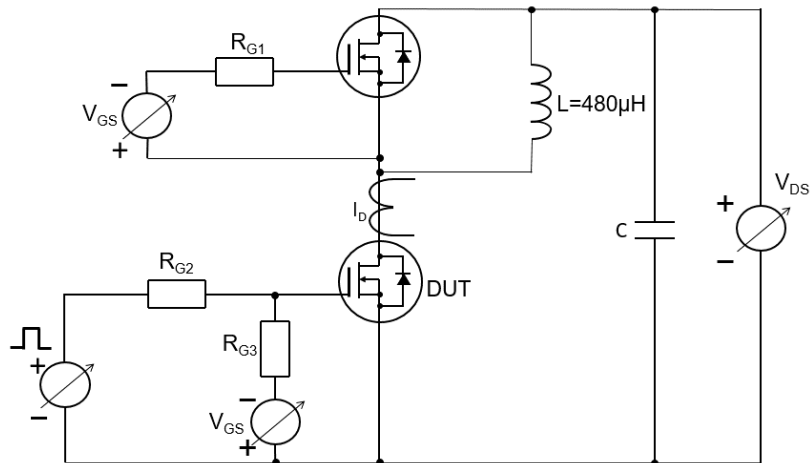

Fig.1 Inductive load switching time test circuit

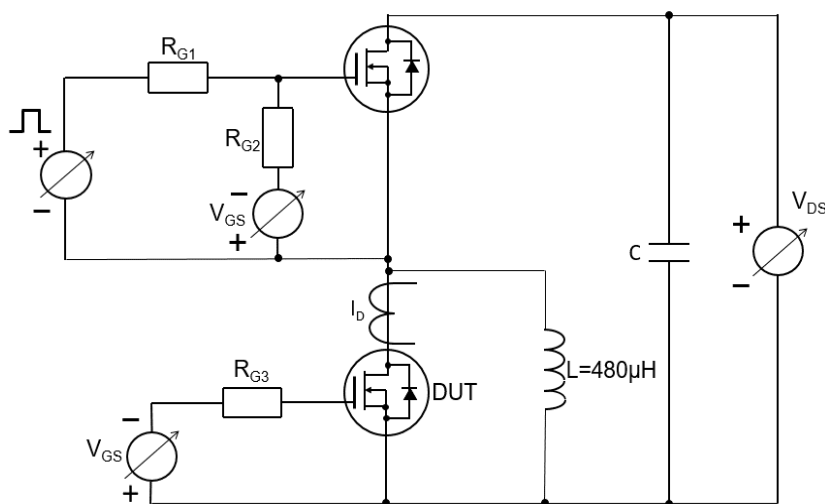

Fig.2 Inductive load recovery switching time test circuit

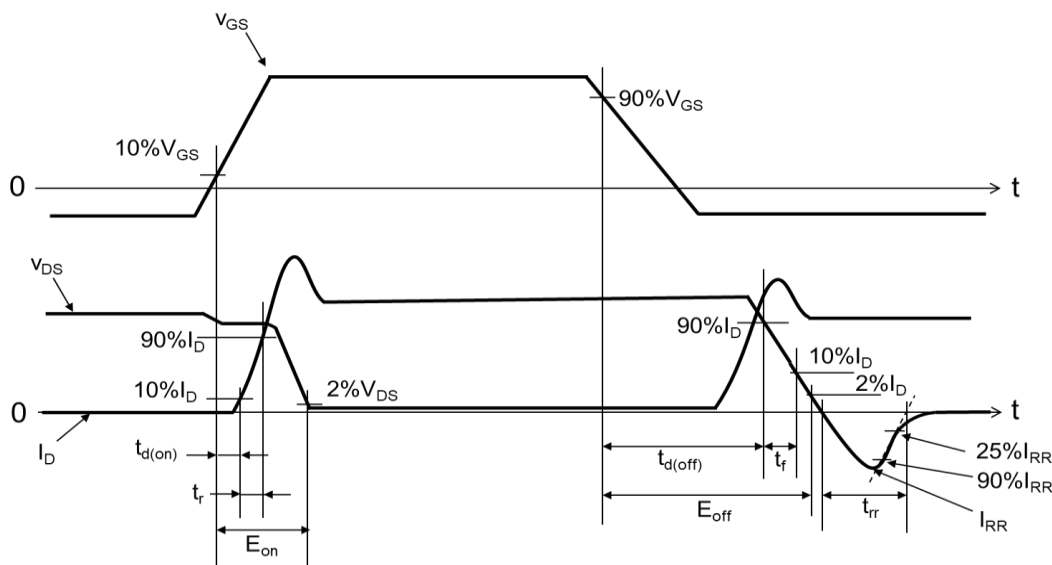

Fig.3 Switching waveform at the time of Inductive load

Fig.4 Output Characteristics (Typical)

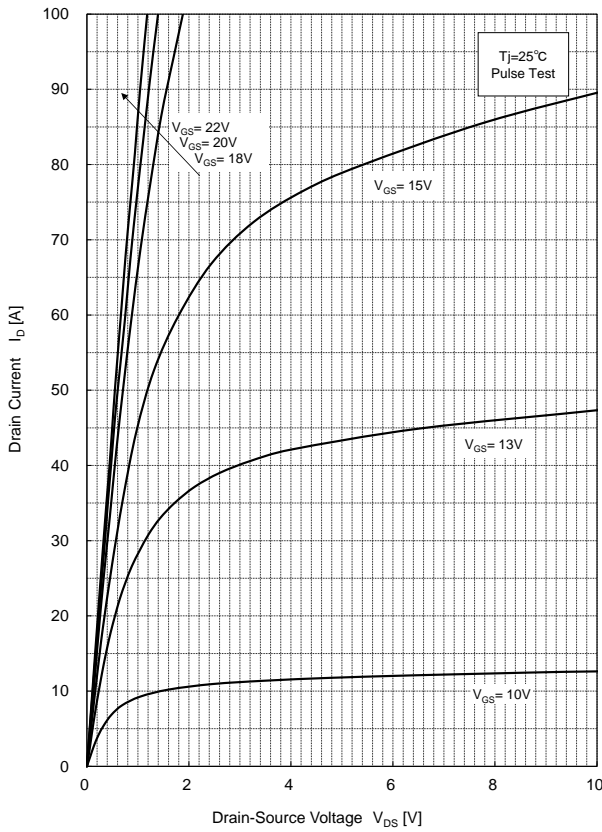

Fig.5 Output Characteristics (Typical)

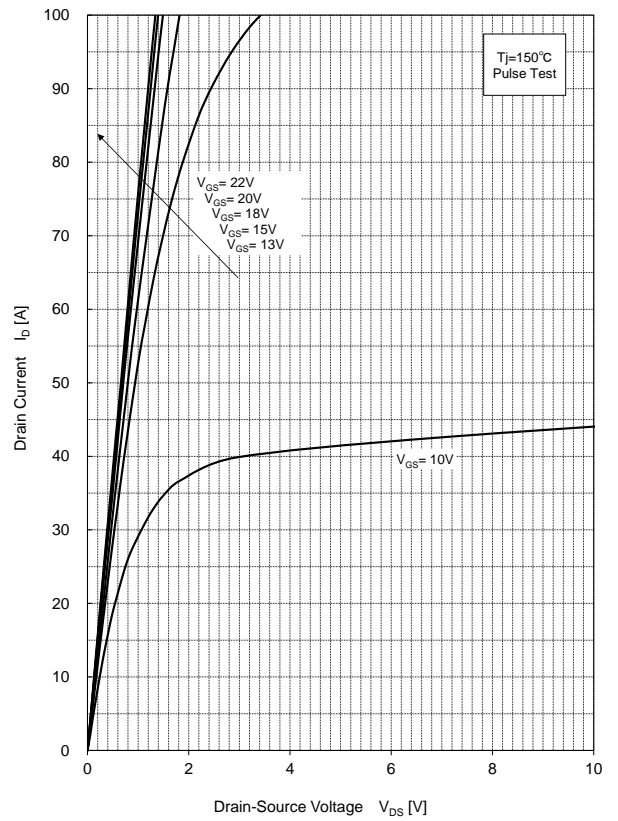

Fig.6 Transfer Characteristics (Typical)

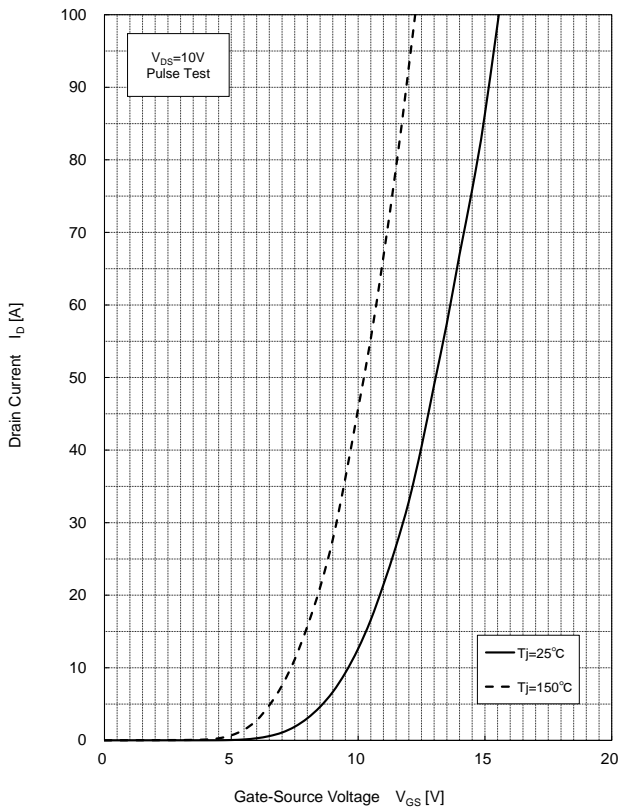

Fig.7 3rd Quadrant Characteristics (Typical)

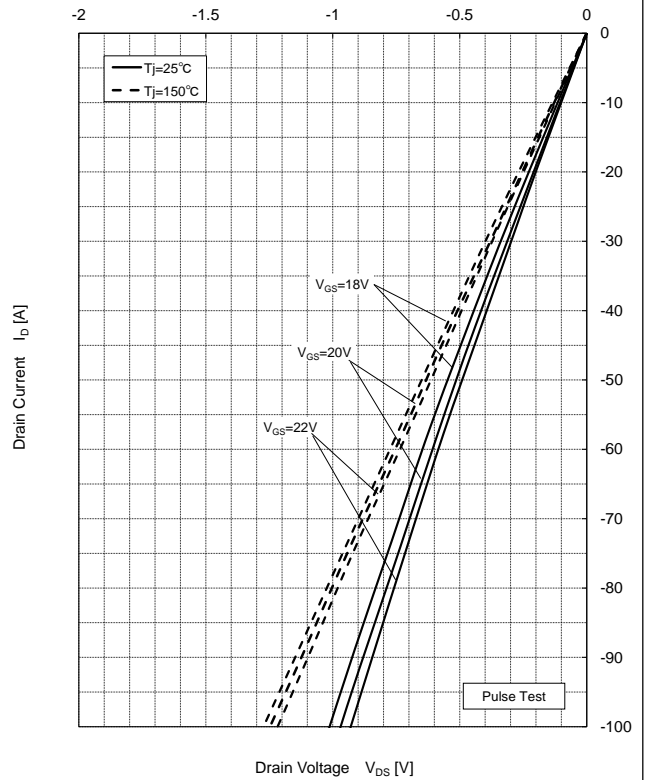

Fig.8 3rd Quadrant Characteristics (Typical)

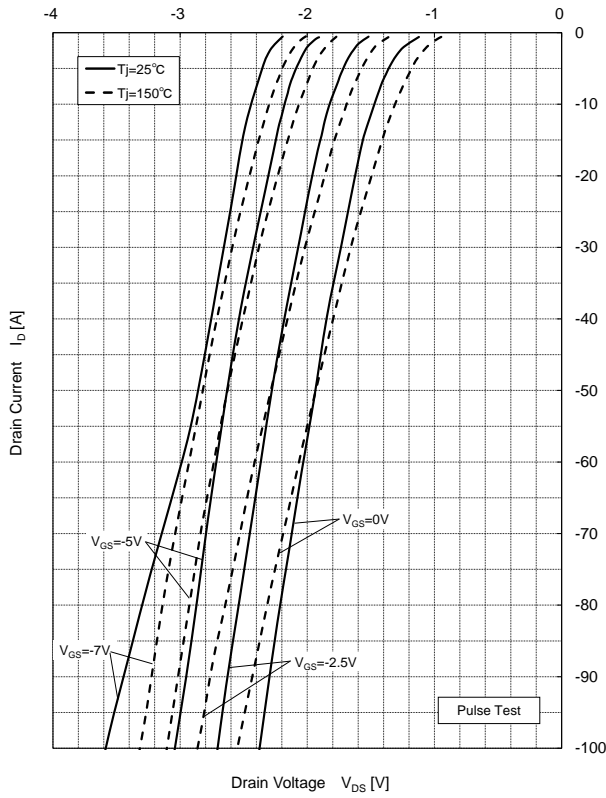

Fig.9 On-State Resistance vs Junction Temperature (Typical)

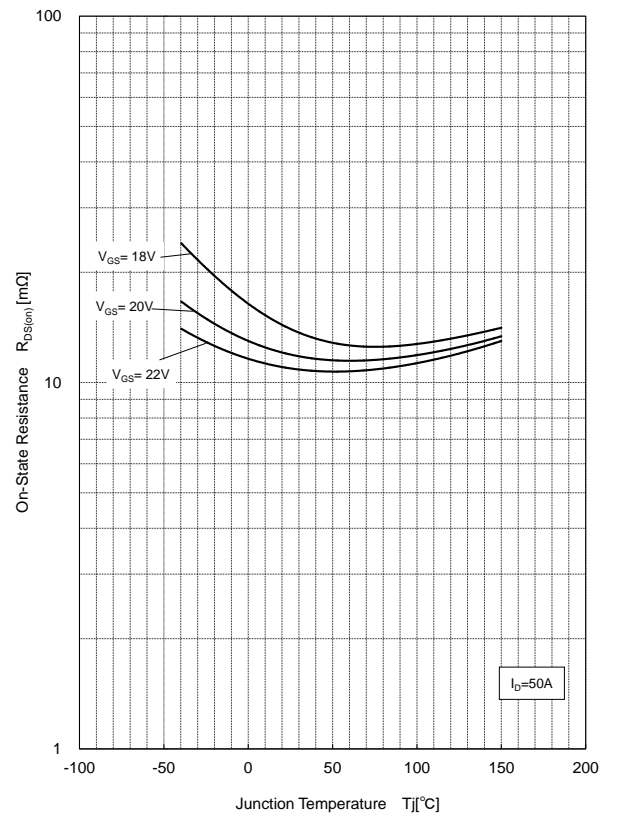

Fig.10 Source-Drain Voltage vs Junction Temperature (Typical)

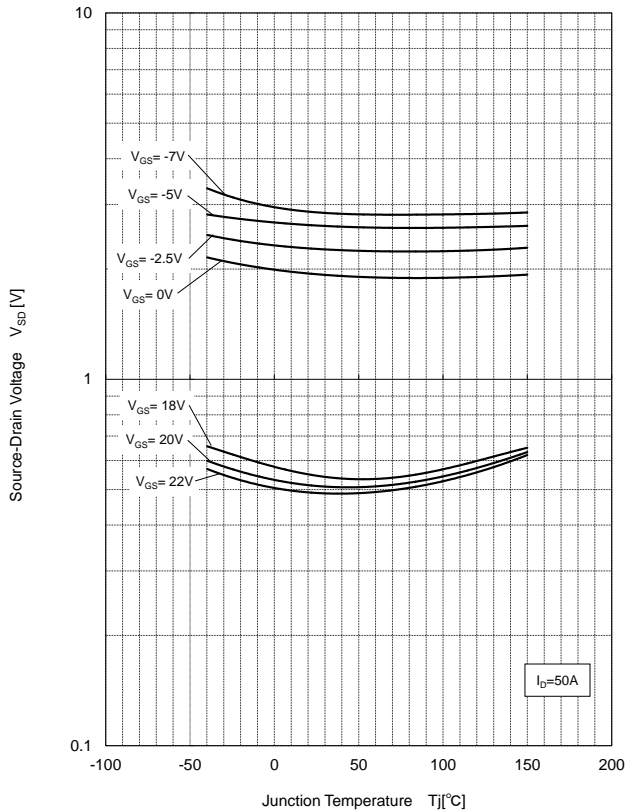

Fig.11 Capacitance (Typical)

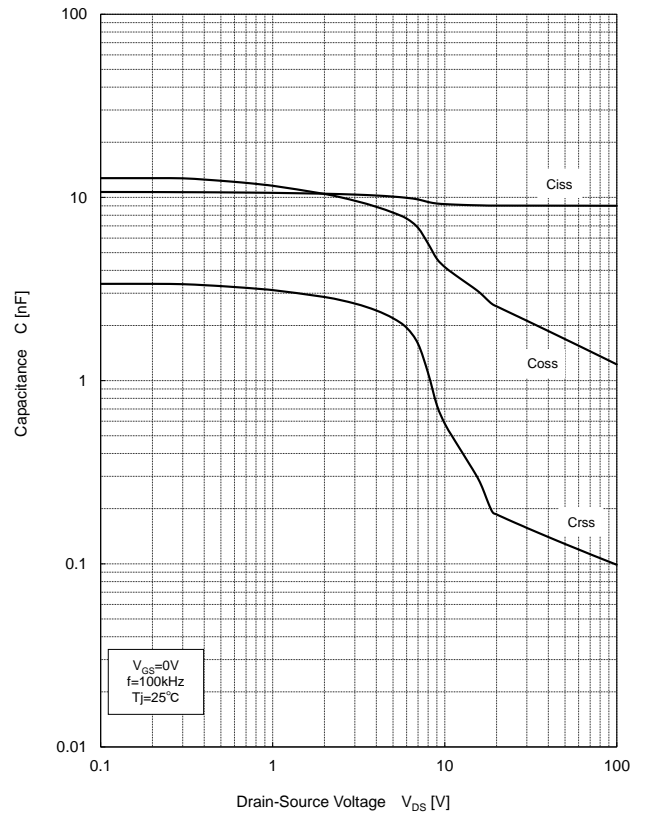

Fig.12 Gate Charge Characteristics (Typical)

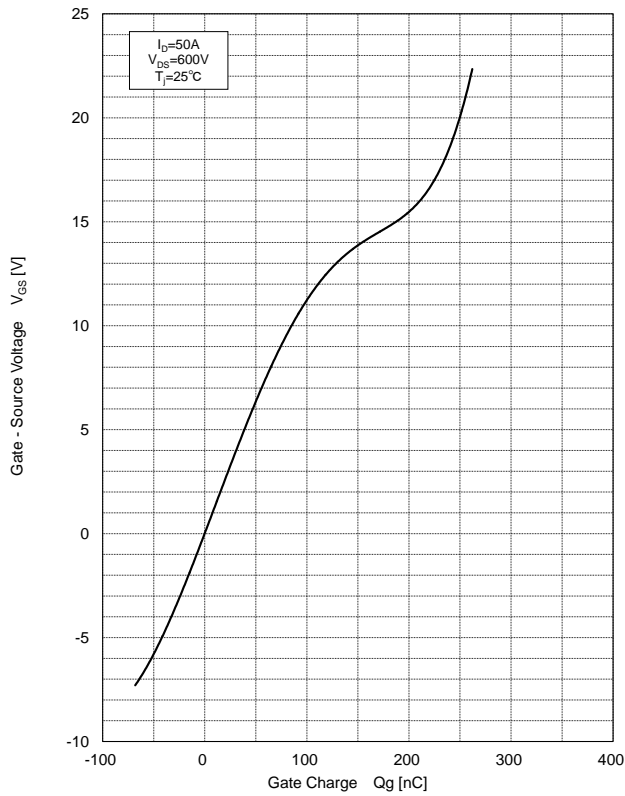

Fig.13 Switching Time vs Drain Current (Typical)

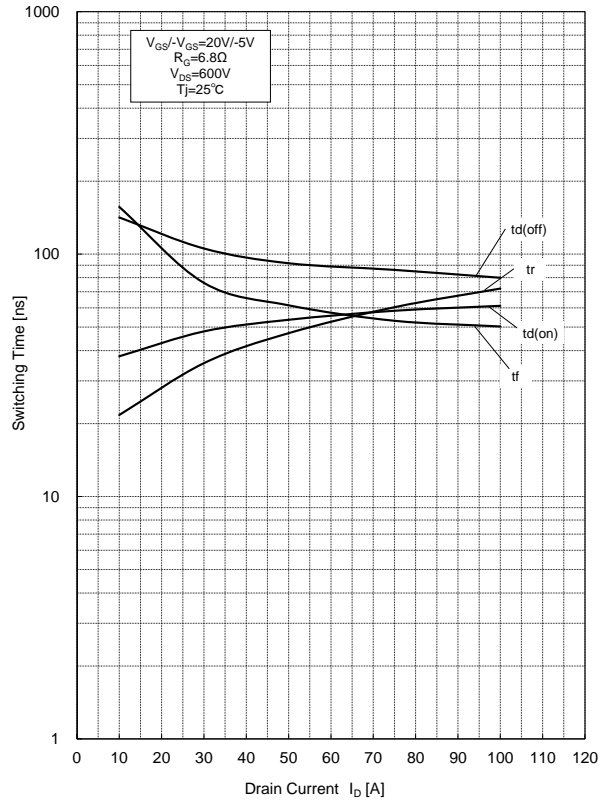

Fig.14 Switching Time vs Drain Current (Typical)

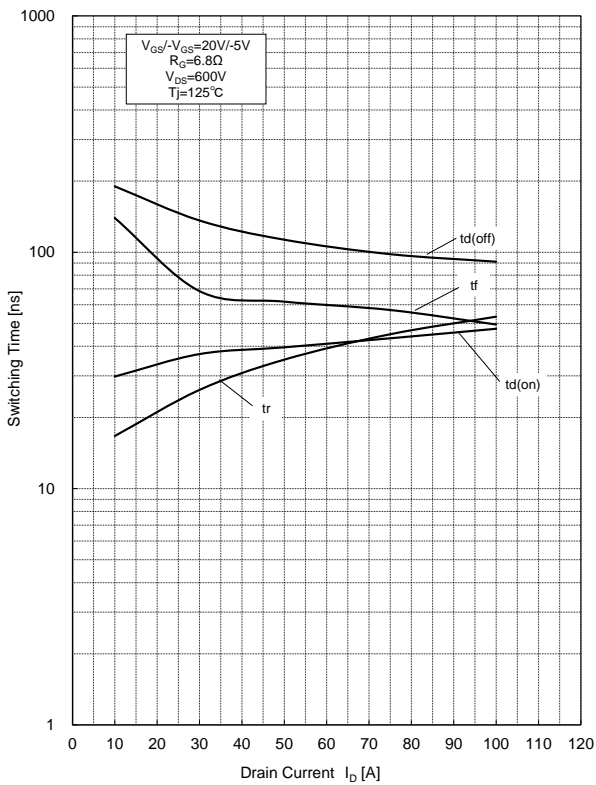

Fig.15 Switching Time vs Drain Current (Typical)

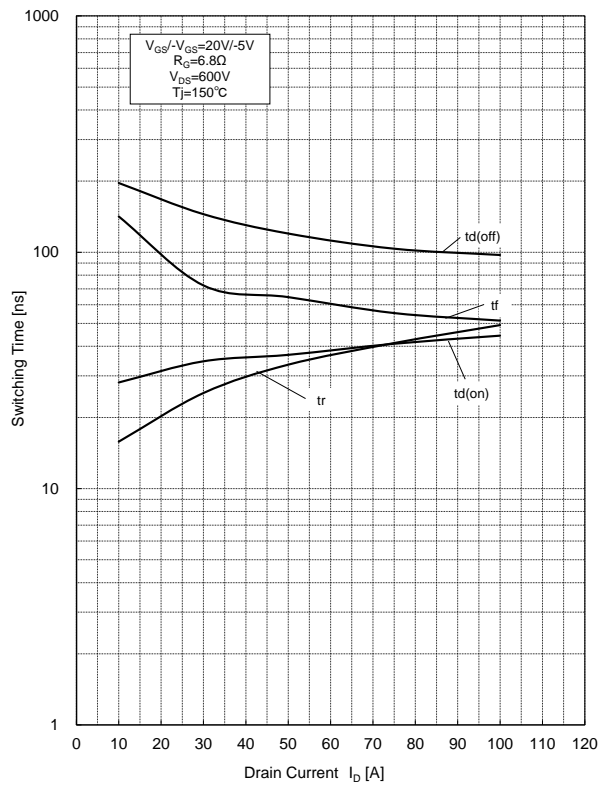

Fig.16 Switching Loss vs Drain Current (Typical)

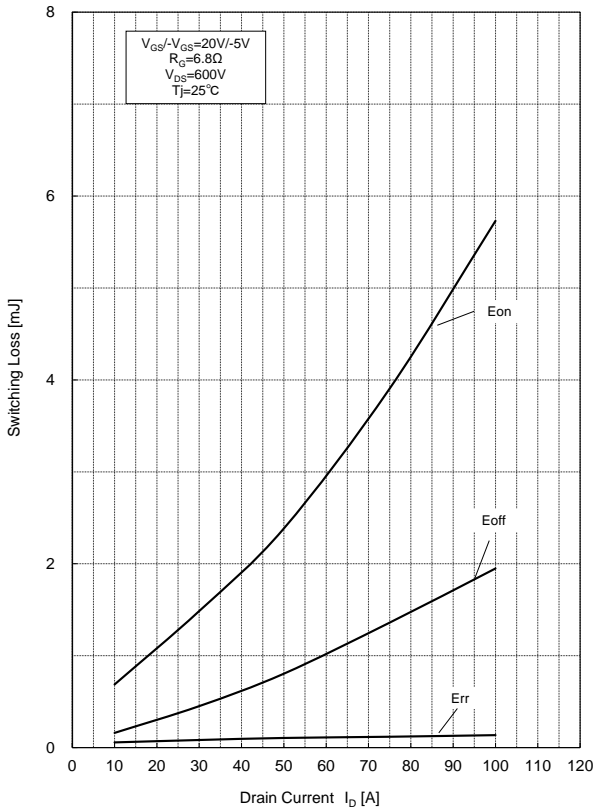

Fig.17 Switching Loss vs Drain Current (Typical)

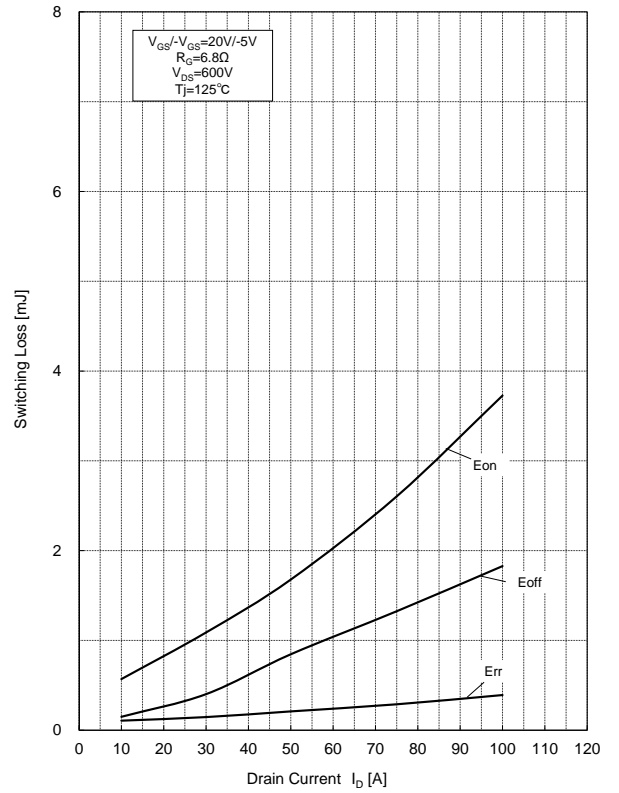

Fig.18 Switching Loss vs Drain Current (Typical)

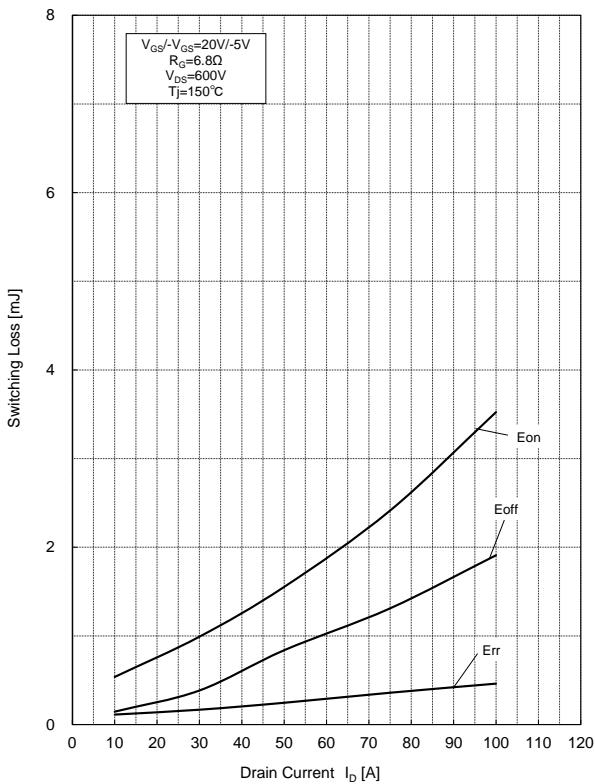

Fig.19 Switching Time vs Gate Resistance (Typical)

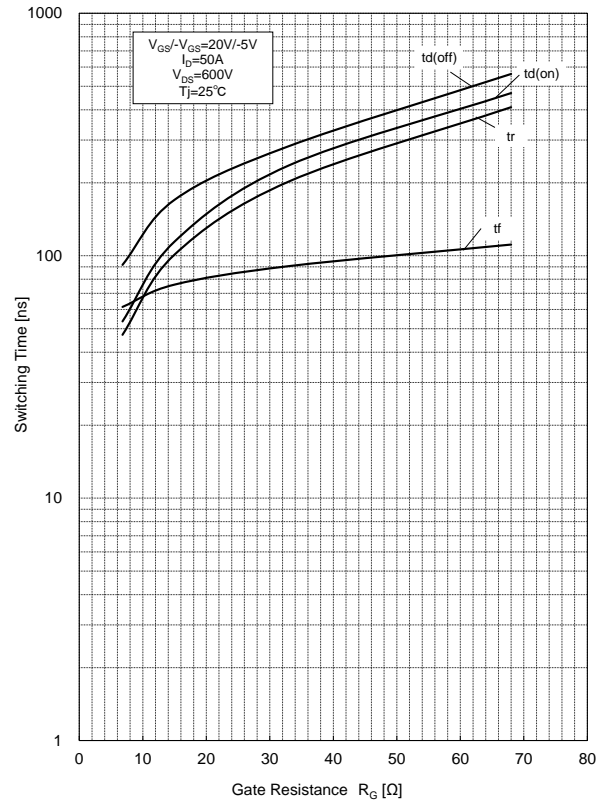

Fig.20 Switching Time vs Gate Resistance (Typical)

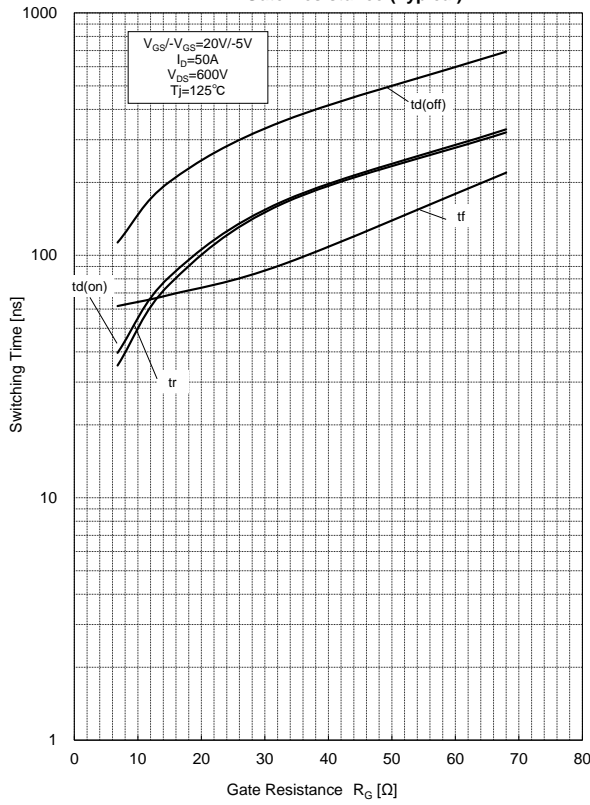

Fig.21 Switching Time vs Gate Resistance (Typical)

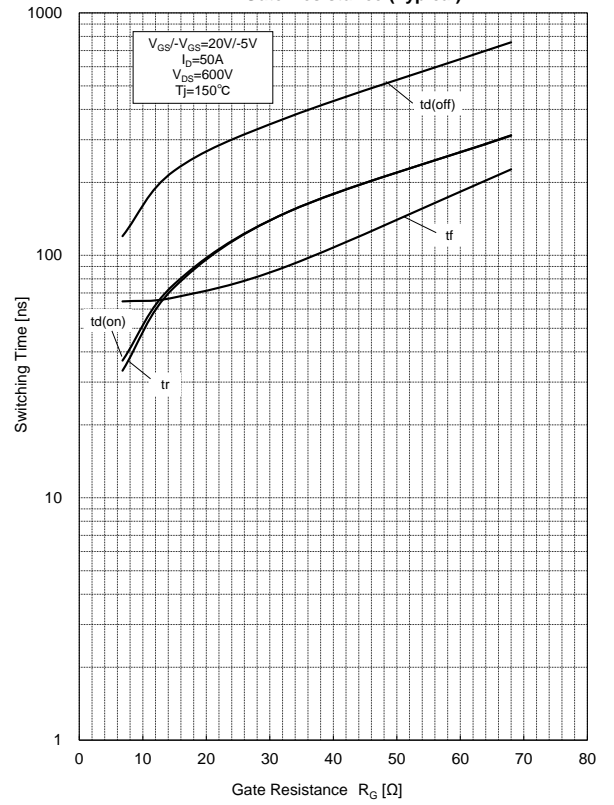

Fig.22 Switching Loss vs Gate Resistance (Typical)

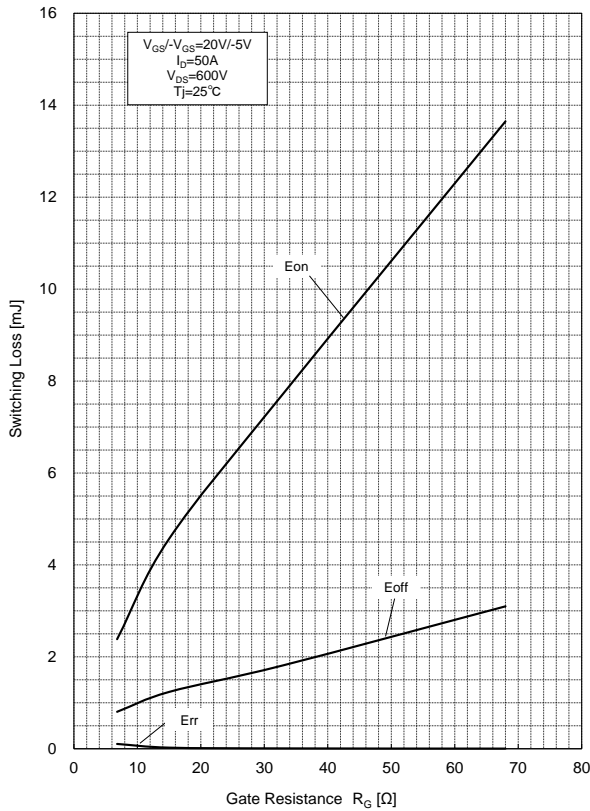

Fig.23 Switching Loss vs Gate Resistance (Typical)

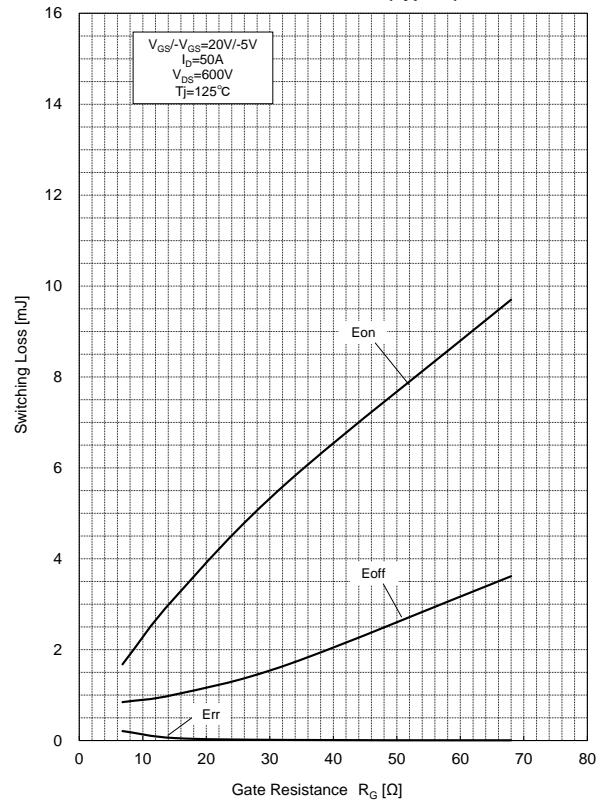

Fig.24 Switching Loss vs Gate Resistance (Typical)

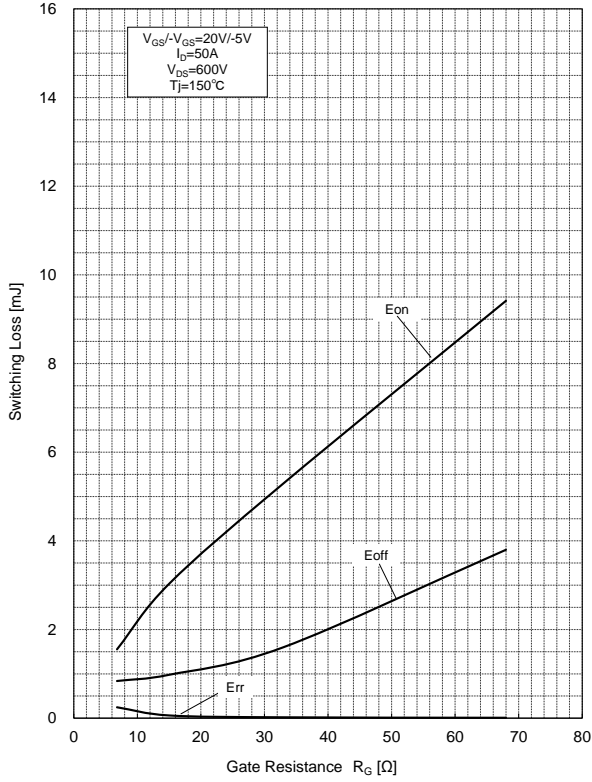

Fig.25 Recovery Characteristics vs Drain Current (Typical)

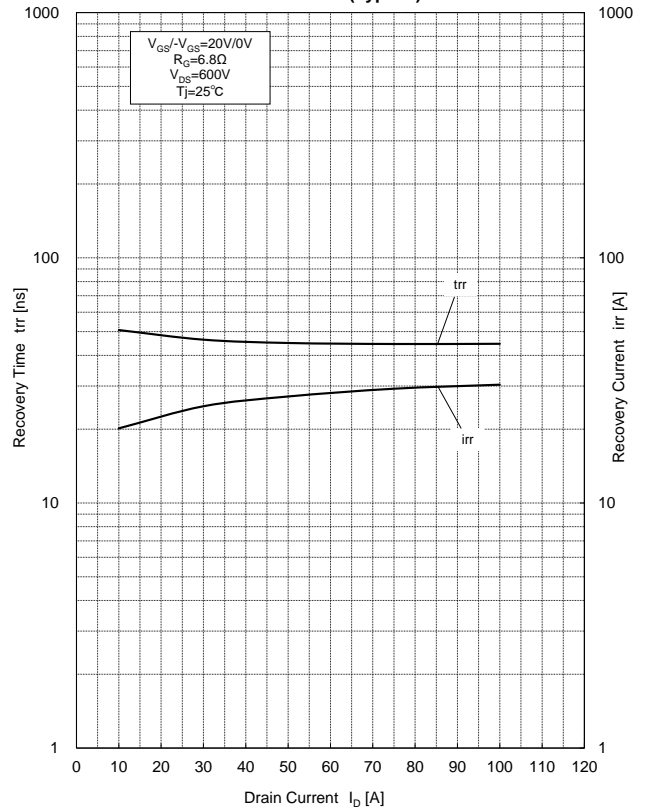

Fig.26 Recovery Characteristics vs Drain Current (Typical)

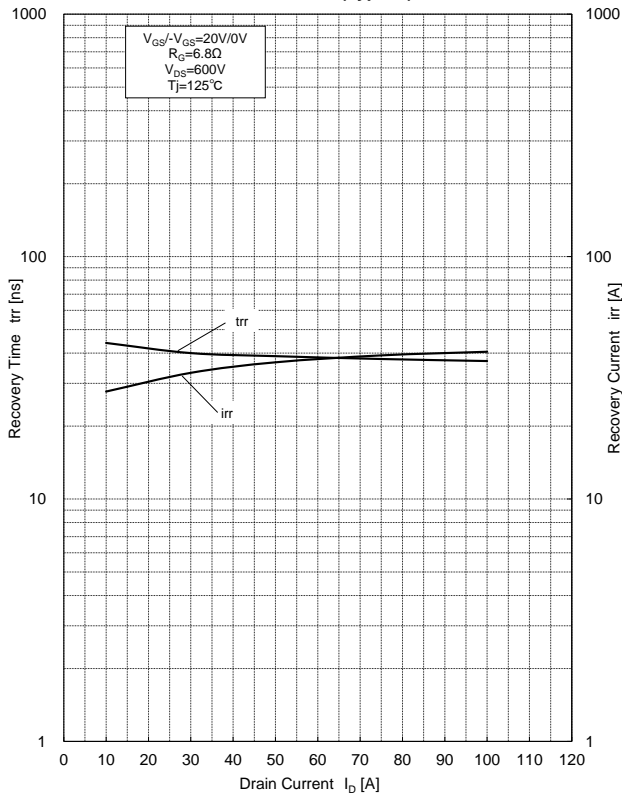

Fig.27 Recovery Characteristics vs Drain Current (Typical)

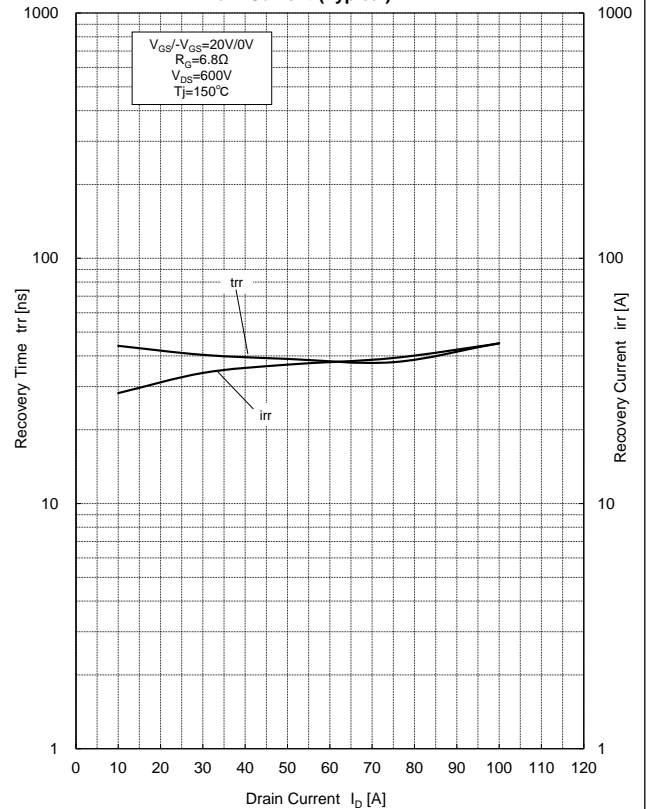

Fig.28 Recovery Characteristics vs Drain Current (Typical)

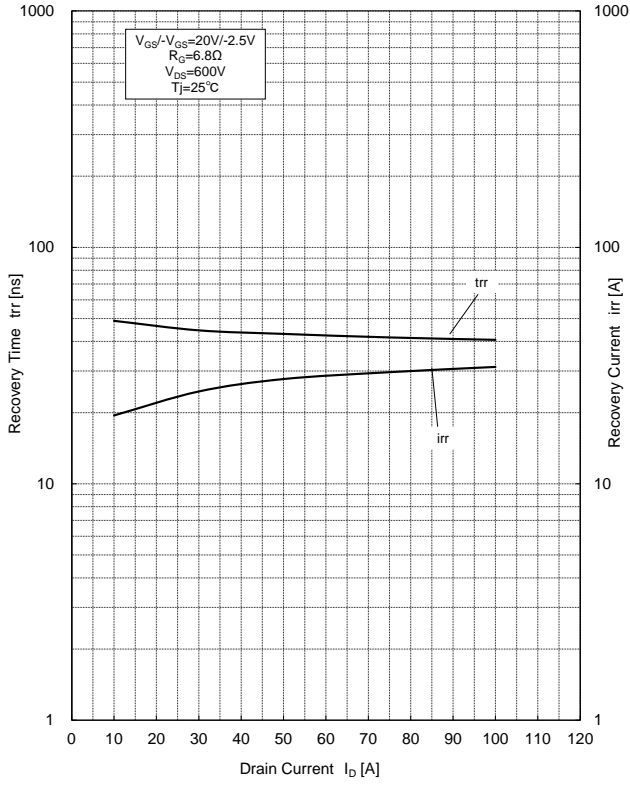

Fig.29 Recovery Characteristics vs Drain Current (Typical)

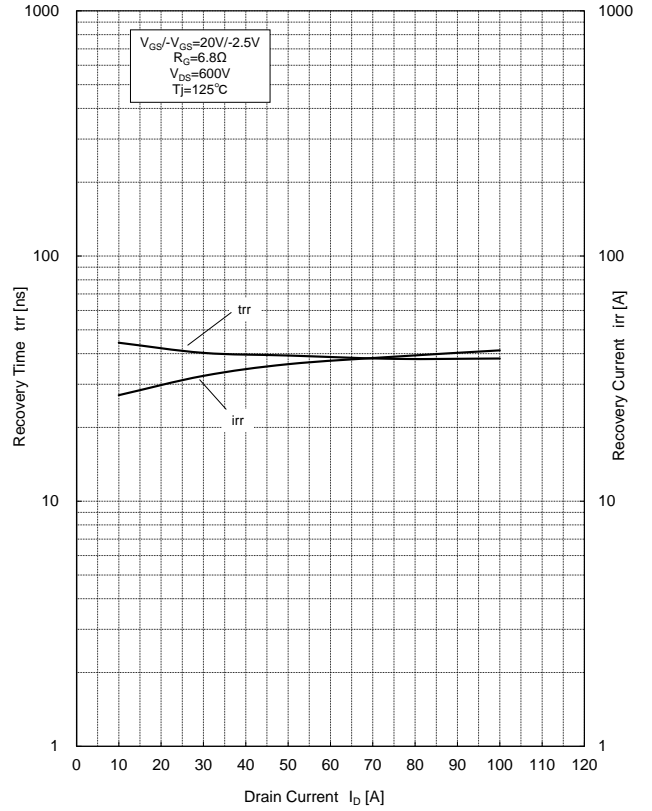

Fig.30 Recovery Characteristics vs Drain Current (Typical)

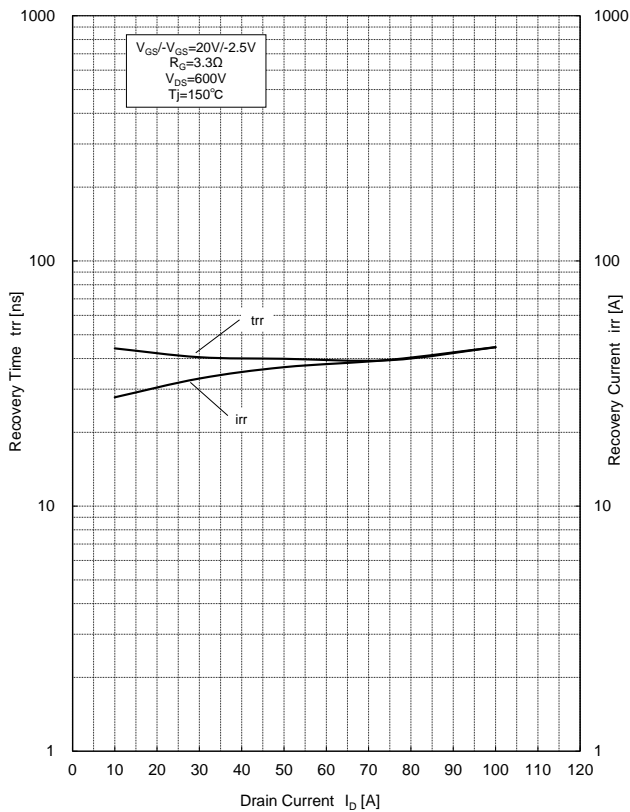

Fig.31 Recovery Characteristics vs Drain Current (Typical)

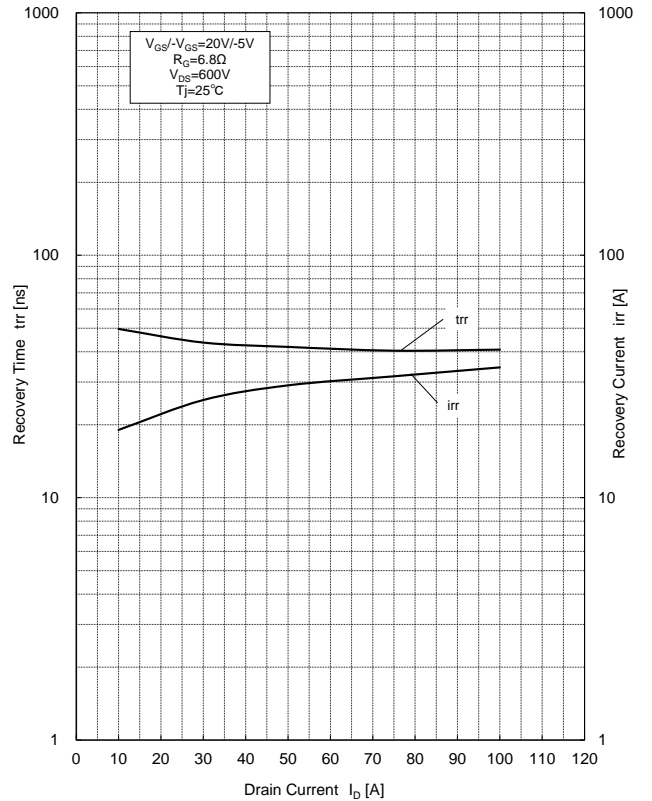

Fig.32 Recovery Characteristics vs Drain Current (Typical)

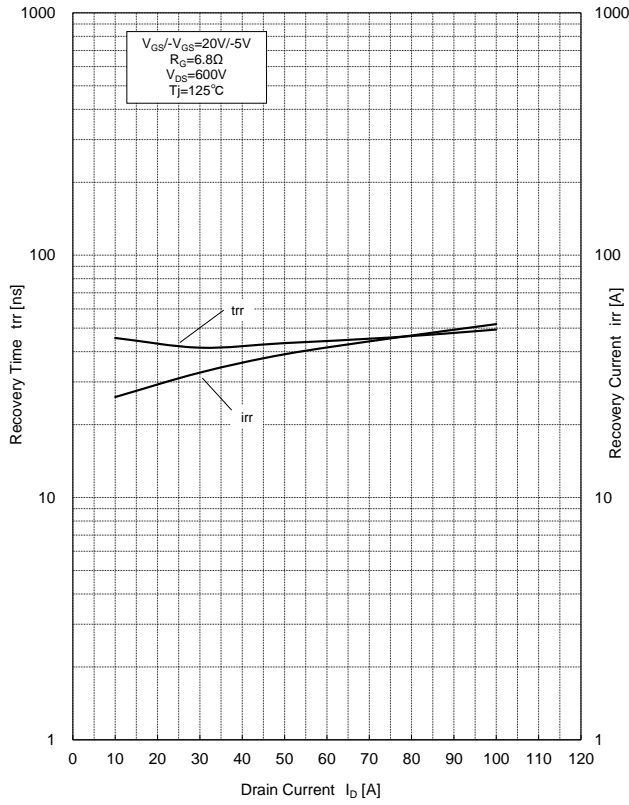

Fig.33 Recovery Characteristics vs Drain Current (Typical)

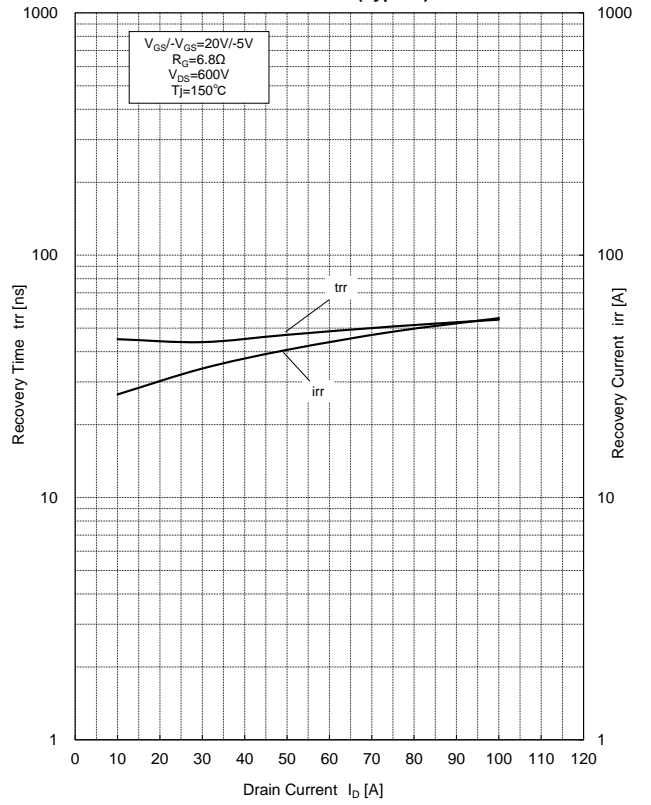

Fig.34 Recovery Characteristics vs Gate Resistance (Typical)

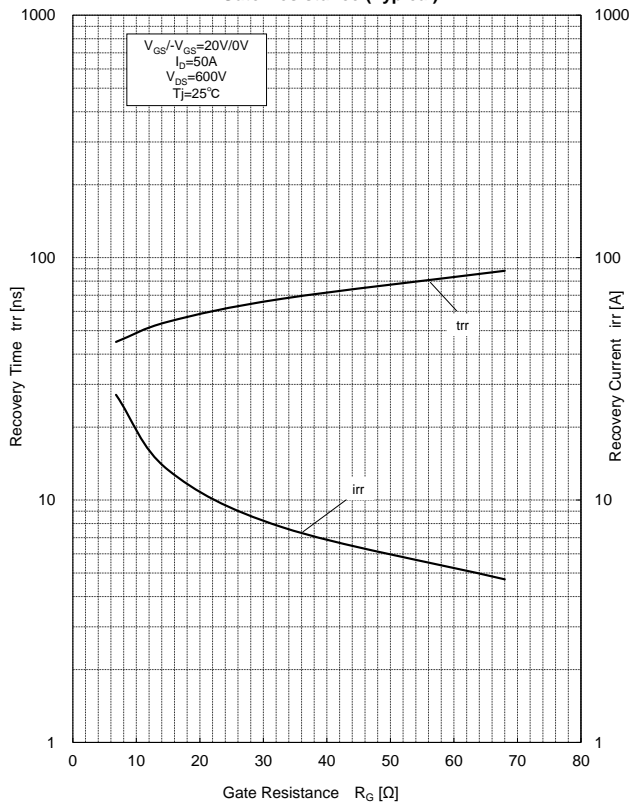

Fig.35 Recovery Characteristics vs Gate Resistance (Typical)

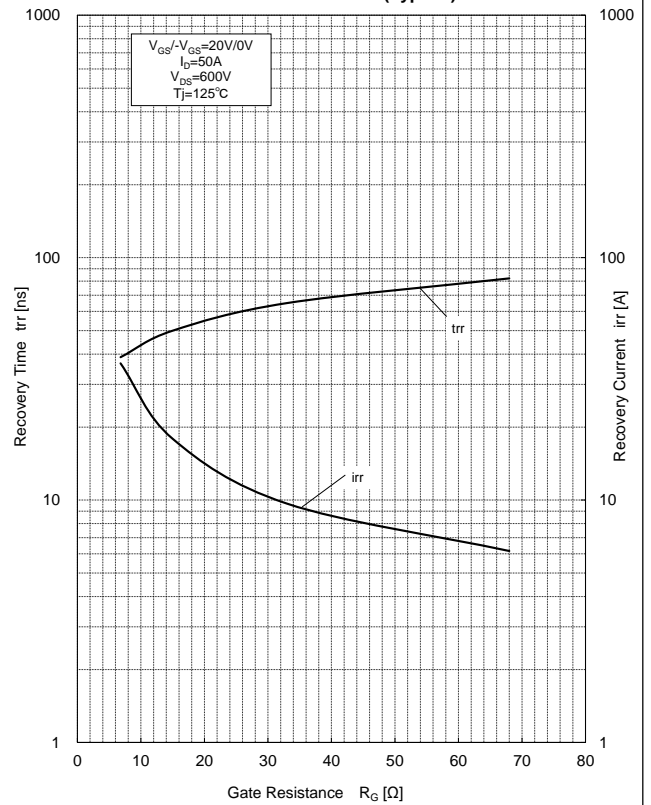

Fig.36 Recovery Characteristics vs Gate Resistance (Typical)

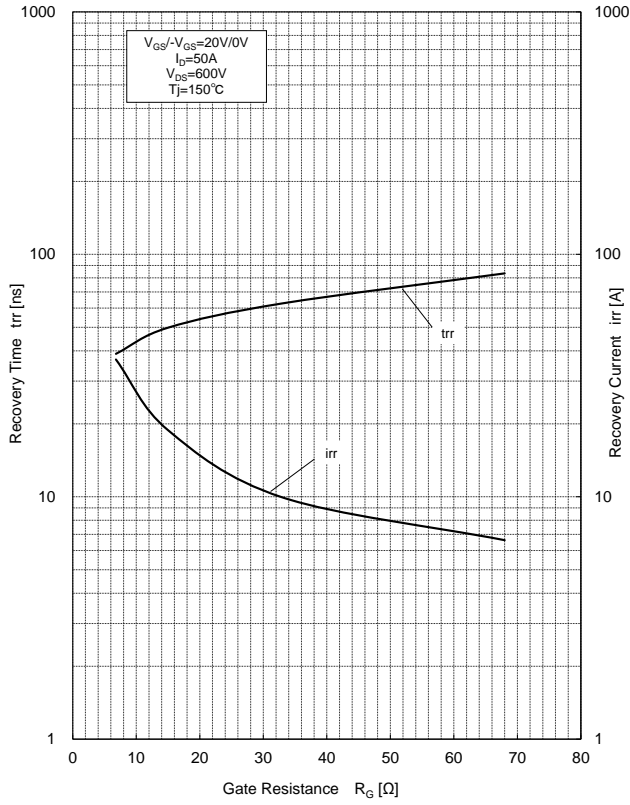

Fig.37 Recovery Characteristics vs Gate Resistance (Typical)

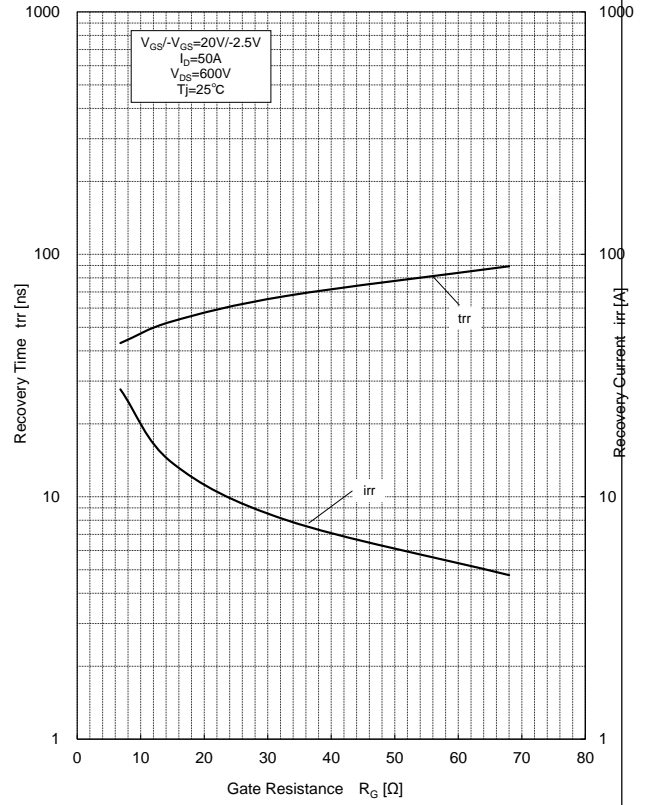

Fig.38 Recovery Characteristics vs Gate Resistance (Typical)

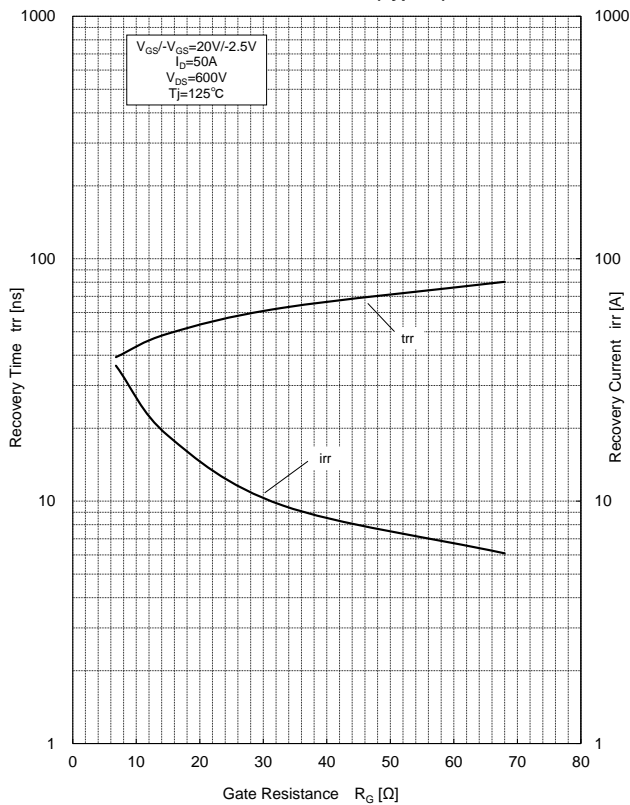

Fig.39 Recovery Characteristics vs Gate Resistance (Typical)

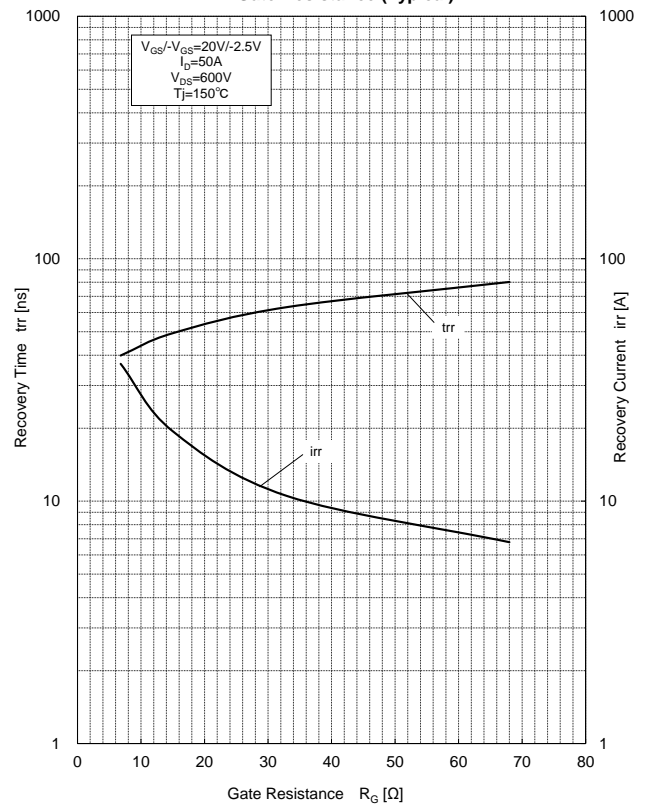

Fig.40 Recovery Characteristics vs Gate Resistance (Typical)

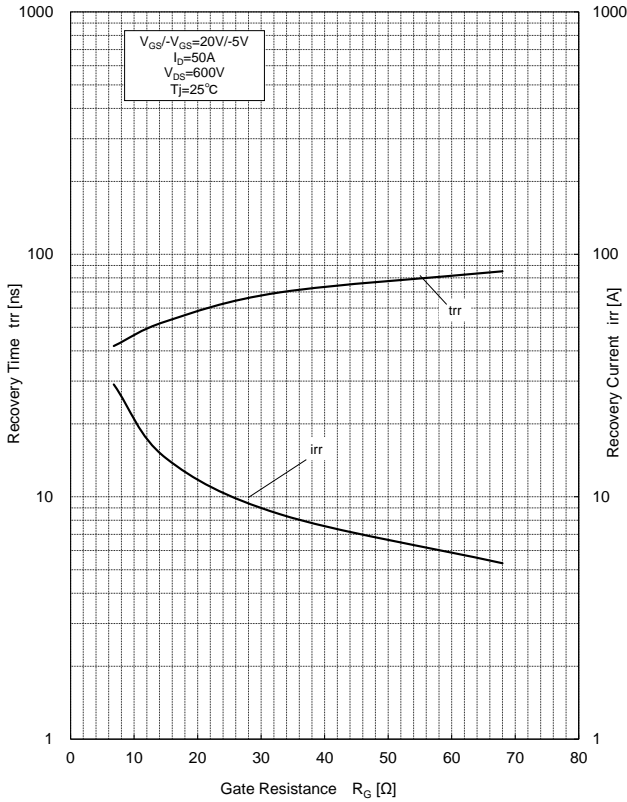

Fig.41 Recovery Characteristics vs Gate Resistance (Typical)

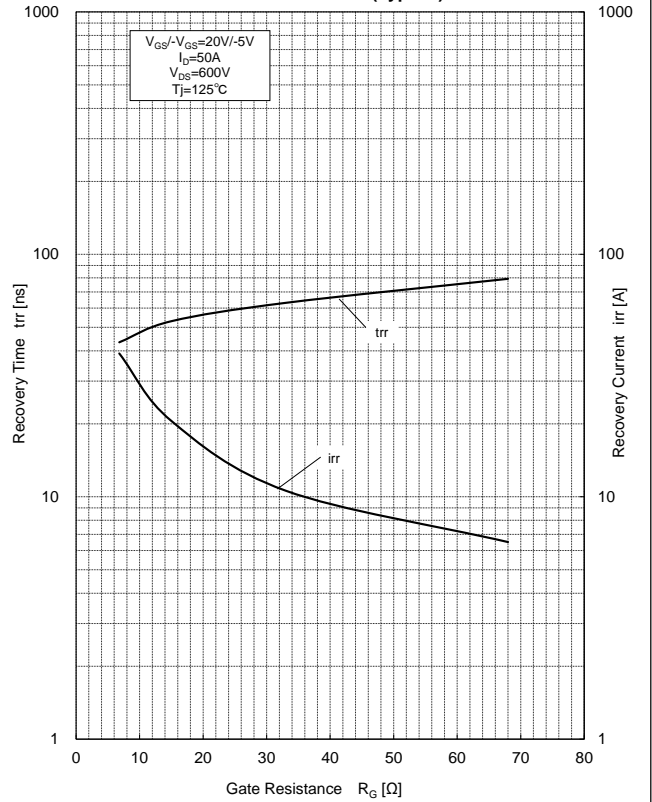

Fig.42 Recovery Characteristics vs Gate Resistance (Typical)

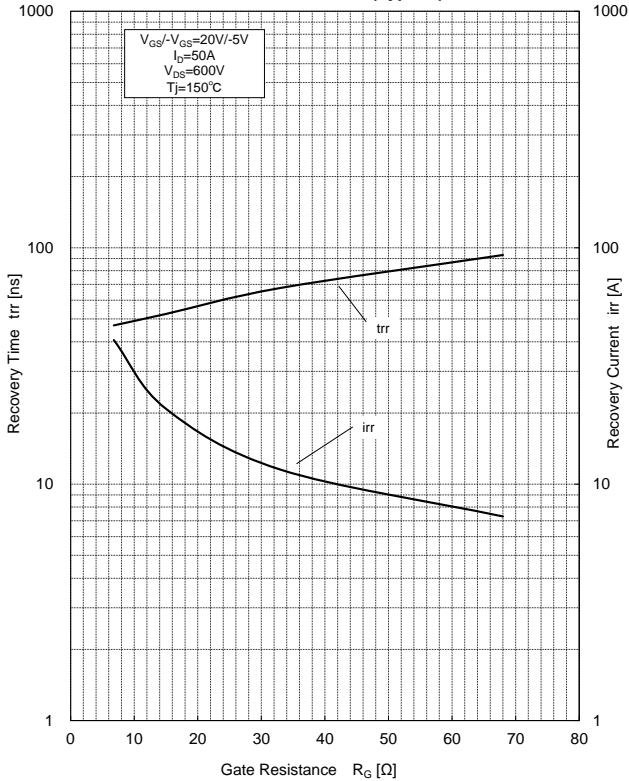

Fig.43 Safe Operating Area

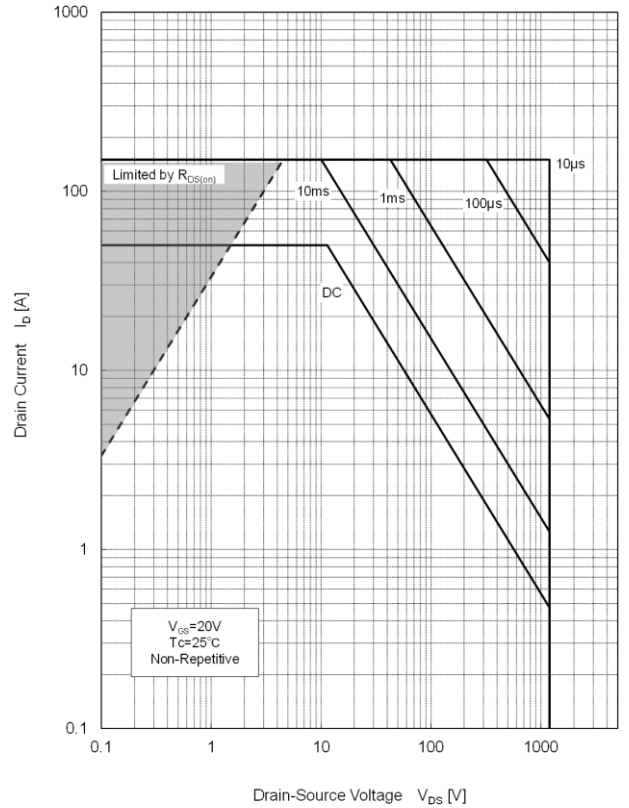
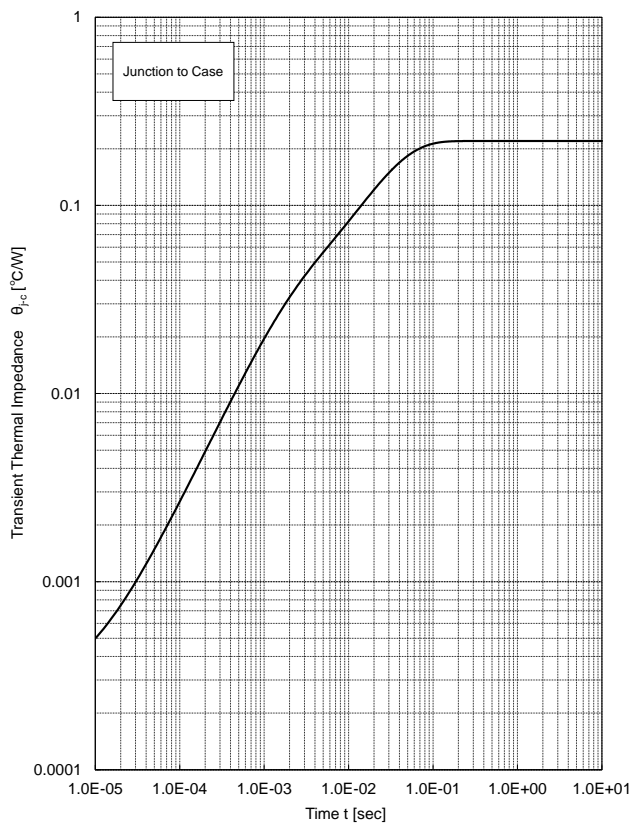

Fig.44 Transient Thermal Impedance



<Attention>

- Although we make every effort to improve quality and reliability, semiconductor products may fail or malfunction due to various factors. When using this product, safety measures should be taken for the equipment on which the product will be used, such as redundancy design, design for prevention of the spread of fire, design for prevention of malfunction, etc. in which safety is taken into consideration, so that no accident resulting in personal injury or death, or no damages due to fire, will occur.
- We will not be held responsible for any accidents or damages that have occurred due to use exceeding the rated values or non-observance of precautions.
- If a product described in this material is subject to regulations under the Foreign Exchange and Foreign Trade Act, permission for export is required to be obtained from the Government of Japan under the said Act, in order to export the product.
- Do not use the product for purposes of development, etc. of weapons of mass destruction or for purposes of military utilization, etc.
- Consult us if you have any questions about the product.

<ご注意>

- 弊社は品質・信頼性の向上に努めておりますが、半導体製品は様々な要因で故障や誤動作をする場合があります。本製品を使用される場合は、人身事故、火災などによる損害が起こらないようご使用機器での、安全性を考慮した冗長設計、延焼防止設計、誤動作防止設計などの安全措置をとってください。
- 定格を超えるご使用や注意事項を守っていないために生じたいかなる事故や損害に対し、弊社は責任を負うものではありません。
- 本資料に掲載されている製品が、外国為替及び外国貿易法に基づき規制されている場合、輸出には同法に基づく日本国政府の輸出許可が必要です。
- 大量破壊兵器の開発等の目的や、軍事利用等の目的で使用しないでください。
- 製品についてご不明な点は弊社にご照会ください。